

Leica GS18



User Manual
Version 2.0
English

- when it has to be **right**

Leica
Geosystems

PART OF
HEXAGON

Introduction

Purchase

Congratulations on the purchase of the Leica GS18.



This manual contains important safety directions as well as instructions for setting up the product and operating it. Refer to [1 Safety Directions](#) for further information.

Read carefully through the User Manual before you switch on the product.



The content of this document is subject to change without prior notice. Ensure that the product is used in accordance with the latest version of this document.

Updated versions are available for download at the following Internet address:

<https://myworld.leica-geosystems.com> > myDownloads.

Product identification

The model and serial number of your product are indicated on the type plate. Always refer to this information when you need to contact your agency or Leica Geosystems authorised service centre.

Trademarks

- *Bluetooth*[®] is a registered trademark of Bluetooth SIG, Inc.

All other trademarks are the property of their respective owners.

Validity of this manual

This manual applies to all models of the Leica GS18 GNSS instrument. Where there are differences between the various instruments they are clearly described.

Available documentation

Name	Description/Format		
GS18 Quick Guide	Provides an overview of the product together with technical data and safety directions. Intended as a quick reference guide.	✓	✓
GS18 User Manual	All instructions required in order to operate the product to a basic level are contained in the User Manual. Provides an overview of the product together with technical data and safety directions.	-	✓

Name	Description/Format		
Captivate Technical Reference Manual	Overall comprehensive guide to the product and apps. Included are detailed descriptions of special software/hardware settings and software/hardware functions intended for technical specialists.	-	✓



Refer to the following resources for documentation/software:

- the Leica Captivate USB documentation card
- <https://myworld.leica-geosystems.com>

myWorld@Leica Geosystems (<https://myworld.leica-geosystems.com>) offers a wide range of services, information and training material.

With direct access to myWorld, you are able to access all relevant services whenever it is convenient for you.

Service	Description
myProducts	Add all products that you and your company own and explore your world of Leica Geosystems: View detailed information on your products and update your products with the latest software and keep up-to-date with the latest documentation.
myService	View the current service status and full service history of your products in Leica Geosystems service centres. Access detailed information on the services performed and download your latest calibration certificates and service reports.
mySupport	Create new support requests for your products that will be answered by your local Leica Geosystems Support Team. View the complete history of your support requests and view detailed information on each request in case you want to refer to previous support requests.
myTraining	Enhance your product knowledge with Leica Geosystems Campus - Information, Knowledge, Training. Study the latest online training material on your products and register for seminars or courses in your country.
myTrustedServices	Add your subscriptions and manage users for Leica Geosystems Trusted Services, the secure software services, that assist you to optimise your workflow and increase your efficiency.

Table of Contents

1	Safety Directions	5
1.1	General Introduction	5
1.2	Definition of Use	6
1.3	Limits of Use	6
1.4	Responsibilities	6
1.5	Hazards of Use	7
1.6	Electromagnetic Compatibility (EMC)	12
1.7	FCC Statement, Applicable in U.S.	14
1.8	ISED Statements (EN/FR), Applicable in Canada	15
2	Description of the System	16
2.1	System Components	16
2.2	System Concept	16
2.2.1	Software Concept	16
2.2.2	Power Concept	17
2.2.3	Data Storage Concept	17
2.3	Container Contents	18
2.4	Instrument Components	20
3	User Interface	22
3.1	Keyboard	22
3.2	Operating Principles	24
4	Operation	25
4.1	Equipment Setup	25
4.1.1	Setting up as a Post-Processing Base	25
4.1.2	Setting up as a Real-Time Base	26
4.1.3	Setting up as a Real-Time Rover	29
4.1.4	Fixing the Field Controller to a Holder and Pole	32
4.1.5	Connecting to a Personal Computer	34
4.1.6	Connecting to the Web Server	36
4.2	Batteries	38
4.2.1	Operating Principles	38
4.2.2	Battery for GS18	39
4.3	Working with the SD Card	39
4.4	Working with the Tilt Compensation	40
4.5	Working with the GS imaging App	44
4.6	LED Indicators on GS18	47
4.7	Guidelines for Correct Results with GNSS Surveys	49
5	Care and Transport	50
5.1	Transport	50
5.2	Storage	50
5.3	Cleaning and Drying	50
6	Technical Data	52
6.1	GS18 Technical Data	52
6.1.1	Tracking Characteristics	52
6.1.2	Accuracy	52
6.1.3	Technical Data	53
6.2	Conformity to National Regulations	55
6.2.1	GS18	55
6.2.2	Dangerous Goods Regulations	57
7	Software Licence Agreement/Warranty	58
Appendix A	Pin Assignments and Sockets	59

1 Safety Directions

1.1 General Introduction

Description

The following directions enable the person responsible for the product, and the person who actually uses the equipment, to anticipate and avoid operational hazards.

The person responsible for the product must ensure that all users understand these directions and adhere to them.

About warning messages





Warning messages are an essential part of the safety concept of the instrument. They appear wherever hazards or hazardous situations can occur.

Warning messages...

- make the user alert about direct and indirect hazards concerning the use of the product.
- contain general rules of behaviour.

For the users' safety, all safety instructions and safety messages shall be strictly observed and followed! Therefore, the manual must always be available to all persons performing any tasks described here.

DANGER, WARNING, CAUTION and **NOTICE** are standardised signal words for identifying levels of hazards and risks related to personal injury and property damage. For your safety, it is important to read and fully understand the following table with the different signal words and their definitions! Supplementary safety information symbols may be placed within a warning message as well as supplementary text.

Type	Description
 DANGER	Indicates an imminently hazardous situation which, if not avoided, will result in death or serious injury.
 WARNING	Indicates a potentially hazardous situation or an unintended use which, if not avoided, could result in death or serious injury.
 CAUTION	Indicates a potentially hazardous situation or an unintended use which, if not avoided, may result in minor or moderate injury.
NOTICE	Indicates a potentially hazardous situation or an unintended use which, if not avoided, may result in appreciable material, financial and environmental damage.
	Important paragraphs which must be adhered to in practice as they enable the product to be used in a technically correct and efficient manner.

1.2

Definition of Use

Intended use

- Computing with software
- Recording measurements
- Carrying out measurement tasks using various GNSS measuring techniques
- Recording GNSS and point related data
- Remote control of product
- Data communication with external appliances
- Measuring raw data and computing coordinates using carrier phase and code signal from GNSS satellites (GNSS systems)
- Capturing image groups and computing 3D coordinates of points using images

Reasonably foreseeable misuse

- Use of the product without instruction
- Use outside of the intended use and limits
- Disabling safety systems
- Removal of hazard notices
- Opening the product using tools, for example screwdriver, unless this is permitted for certain functions
- Modification or conversion of the product
- Use after misappropriation
- Use of products with recognisable damage or defects
- Use with accessories from other manufacturers without the prior explicit approval of Leica Geosystems
- Inadequate safeguards at the working site
- Controlling of machines, moving objects or similar monitoring application without additional control and safety installations

1.3

Limits of Use

Environment

Suitable for use in an atmosphere appropriate for permanent human habitation: not suitable for use in aggressive or explosive environments.

WARNING

Working in hazardous areas, or close to electrical installations or similar situations

Life Risk.

Precautions:

- ▶ Local safety authorities and safety experts must be contacted by the person responsible for the product before working in such conditions.

1.4

Responsibilities

Manufacturer of the product

Leica Geosystems AG, CH-9435 Heerbrugg, hereinafter referred to as Leica Geosystems, is responsible for supplying the product, including the User Manual and original accessories, in a safe condition.

Person responsible for the product

The person responsible for the product has the following duties:

- To understand the safety instructions on the product and the instructions in the User Manual
- To ensure that it is used in accordance with the instructions
- To be familiar with local regulations relating to safety and accident prevention
- To inform Leica Geosystems immediately if the product and the application become unsafe
- To ensure that the national laws, regulations and conditions for the operation of the product are respected
- To ensure that the radio modem is not operated without the permission of the local authorities on frequencies and/or output power levels other than those specifically reserved and intended for use without a specific permit. The internal and external radio modems have been designed to operate on frequency ranges and output power ranges, the exact use of which differs from one region and/or country to another.

1.5

Hazards of Use

DANGER

Risk of electrocution

Because of the risk of electrocution, it is dangerous to use poles, levelling staffs and extensions in the vicinity of electrical installations such as power cables or electrical railways.

Precautions:

- ▶ Keep at a safe distance from electrical installations. If it is essential to work in this environment, first contact the safety authorities responsible for the electrical installations and follow their instructions.



WARNING

Distraction/loss of attention

During dynamic applications, for example stakeout procedures, there is a danger of accidents occurring if the user does not pay attention to the environmental conditions around, for example obstacles, excavations or traffic.

Precautions:

- ▶ The person responsible for the product must make all users fully aware of the existing dangers.

 **WARNING**

Inadequate securing of the working site

This can lead to dangerous situations, for example in traffic, on building sites and at industrial installations.

Precautions:

- ▶ Always ensure that the working site is adequately secured.
 - ▶ Adhere to the regulations governing safety, accident prevention and road traffic.
-

 **CAUTION**

Not properly secured accessories

If the accessories used with the product are not properly secured and the product is subjected to mechanical shock, for example blows or falling, the product may be damaged or people can sustain injury.

Precautions:

- ▶ When setting up the product, make sure that the accessories are correctly adapted, fitted, secured, and locked in position.
 - ▶ Avoid subjecting the product to mechanical stress.
-

 **WARNING**

Lightning strike

If the product is used with accessories, for example masts, staffs, poles, you may increase the risk of being struck by lightning.

Precautions:

- ▶ Do not use the product in a thunderstorm.
-

⚠ DANGER

Risk of being struck by lightning

If the product is used with accessories, for example on masts, staffs, poles, you may increase the risk of being struck by lightning. Danger from high voltages also exists near power lines. Lightning, voltage peaks, or the touching of power lines can cause damage, injury and death.

Precautions:

- ▶ Do not use the product in a thunderstorm as you can increase the risk of being struck by lightning.
- ▶ Be sure to remain at a safe distance from electrical installations. Do not use the product directly under or close to power lines. If it is essential to work in such an environment contact the safety authorities responsible for electrical installations and follow their instructions.
- ▶ If the product has to be permanently mounted in an exposed location, it is advisable to provide a lightning conductor system. A suggestion on how to design a lightning conductor for the product is given below. Always follow the regulations in force in your country regarding grounding antennas and masts. These installations must be carried out by an authorised specialist.
- ▶ To prevent damages due to indirect lightning strikes (voltage spikes) cables, for example for antenna, power source or modem should be protected with appropriate protection elements, like a lightning arrester. These installations must be carried out by an authorised specialist.
- ▶ If there is a risk of a thunderstorm, or if the equipment is to remain unused and unattended for a long period, protect your product additionally by unplugging all systems components and disconnecting all connecting cables and supply cables, for example, instrument - antenna.

Lightning conductors

Suggestion for design of a lightning conductor for a GNSS system:

1. On non-metallic structures
Protection by air terminals is recommended. An air terminal is a pointed solid or tubular rod of conducting material with proper mounting and connection to a conductor. The position of four air terminals can be uniformly distributed around the antenna at a distance equal to the height of the air terminal.
The air terminal diameter should be 12 mm for copper or 15 mm for aluminium. The height of the air terminals should be 25 cm to 50 cm. All air terminals should be connected to the down conductors. The diameter of the air terminal should be kept to a minimum to reduce GNSS signal shading.
2. On metallic structures
Protection is as described for non-metallic structures, but the air terminals can be connected directly to the conducting structure without the need for down conductors.

Air terminal arrangement, plan view

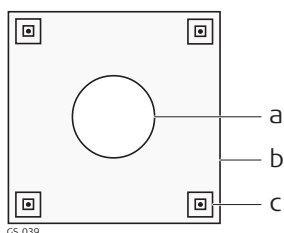

- a Antenna
- b Support structure
- c Air terminal

Grounding the instrument/antenna

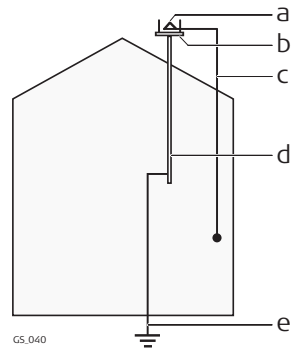

- a Antenna
- b Lightning conductor array
- c Antenna/instrument connection
- d Metallic mast
- e Connection to earth

For the AC/DC power supply:

WARNING

Electric shock due to use under wet and severe conditions

If unit becomes wet it may cause you to receive an electric shock.

Precautions:

- ▶ If the product becomes humid, it must not be used!
- ▶ Use the product only in dry environments, for example in buildings or vehicles.



- ▶ Protect the product against humidity.

For the AC/DC power supply:

WARNING

Unauthorised opening of the product

Either of the following actions may cause you to receive an electric shock:

- Touching live components
- Using the product after incorrect attempts were made to carry out repairs.

Precautions:

- ▶ Do not open the product!
- ▶ Only Leica Geosystems authorised service centres are entitled to repair these products.

 **WARNING**

Inappropriate mechanical influences to batteries

During the transport, shipping or disposal of batteries it is possible for inappropriate mechanical influences to constitute a fire hazard.

Precautions:

- ▶ Before shipping the product or disposing it, discharge the batteries by the product until they are flat.
- ▶ When transporting or shipping batteries, the person in charge of the product must ensure that the applicable national and international rules and regulations are observed.
- ▶ Before transportation or shipping, contact your local passenger or freight transport company.

 **WARNING**

Exposure of batteries to high mechanical stress, high ambient temperatures or immersion into fluids

This can cause leakage, fire or explosion of the batteries.

Precautions:

- ▶ Protect the batteries from mechanical influences and high ambient temperatures. Do not drop or immerse batteries into fluids.

 **WARNING**

Short circuit of battery terminals

If battery terminals are short circuited e.g. by coming in contact with jewellery, keys, metallised paper or other metals, the battery can overheat and cause injury or fire, for example by storing or transporting in pockets.

Precautions:

- ▶ Make sure that the battery terminals do not come into contact with metallic objects.

WARNING

If the product is improperly disposed of, the following can happen:

- If polymer parts are burnt, poisonous gases are produced which may impair health.
- If batteries are damaged or are heated strongly, they can explode and cause poisoning, burning, corrosion or environmental contamination.
- By disposing of the product irresponsibly you may enable unauthorised persons to use it in contravention of the regulations, exposing themselves and third parties to the risk of severe injury and rendering the environment liable to contamination.
- The product includes parts of Beryllium inside. Any modification of some internal parts can release dust or fragments, creating health hazard.

Precautions:



The product must not be disposed with household waste. Dispose of the product appropriately in accordance with the national regulations in force in your country. Always prevent access to the product by unauthorised personnel.

Product-specific treatment and waste management information can be received from your Leica Geosystems distributor.

WARNING

Improperly repaired equipment

Risk of injuries to users and equipment destruction due to lack of repair knowledge.

Precautions:

- ▶ Only authorised Leica Geosystems Service Centres are entitled to repair these products.

1.6

Description

Electromagnetic Compatibility (EMC)

The term Electromagnetic Compatibility is taken to mean the capability of the product to function smoothly in an environment where electromagnetic radiation and electrostatic discharges are present, and without causing electromagnetic disturbances to other equipment.

WARNING

Electromagnetic radiation

Electromagnetic radiation can cause disturbances in other equipment.

Precautions:

- ▶ Although the product meets the strict regulations and standards which are in force in this respect, Leica Geosystems cannot completely exclude the possibility that other equipment may be disturbed.

 **CAUTION**

Use of the product with accessories from other manufacturers. For example field computers, personal computers or other electronic equipment, non-standard cables or external batteries

This may cause disturbances in other equipment.

Precautions:

- ▶ Use only the equipment and accessories recommended by Leica Geosystems.
- ▶ When combined with the product, they meet the strict requirements stipulated by the guidelines and standards.
- ▶ When using computers, two-way radios or other electronic equipment, pay attention to the information about electromagnetic compatibility provided by the manufacturer.

 **CAUTION**

Intense electromagnetic radiation. For example, near radio transmitters, transponders, two-way radios or diesel generators

Although the product meets the strict regulations and standards which are in force in this respect, Leica Geosystems cannot completely exclude the possibility that function of the product may be disturbed in such an electromagnetic environment.

Precautions:

- ▶ Check the plausibility of results obtained under these conditions.

 **CAUTION**

Electromagnetic radiation due to improper connection of cables

If the product is operated with connecting cables attached at only one of their two ends, for example external supply cables, interface cables, the permitted level of electromagnetic radiation may be exceeded and the correct functioning of other products may be impaired.

Precautions:

- ▶ While the product is in use, connecting cables, for example product to external battery, product to computer, must be connected at both ends.

⚠ WARNING

Use of product with radio or digital cellular phone devices

Electromagnetic fields can cause disturbances in other equipment, in installations, in medical devices, for example pacemakers or hearing aids and in aircrafts. Electromagnetic fields can also affect humans and animals.

Precautions:

- ▶ Although the product meets the strict regulations and standards which are in force in this respect, Leica Geosystems cannot completely exclude the possibility that other equipment can be disturbed or that humans or animals can be affected.
- ▶ Do not operate the product with radio or digital cellular phone devices in the vicinity of filling stations or chemical installations, or in other areas where an explosion hazard exists.
- ▶ Do not operate the product with radio or digital cellular phone devices near to medical equipment.
- ▶ Do not operate the product with radio or digital cellular phone devices in aircrafts.
- ▶ Do not operate the product with radio or digital cellular phone devices for long periods with the product immediately next to your body.

1.7

FCC Statement, Applicable in U.S.



The greyed paragraph below is only applicable for products without radio.

⚠ WARNING

This equipment has been tested and found to comply with the limits for a Class B digital device, pursuant to part 15 of the FCC rules.

These limits are designed to provide reasonable protection against harmful interference in a residential installation.

This equipment generates, uses and can radiate radio frequency energy and, if not installed and used in accordance with the instructions, may cause harmful interference to radio communications. However, there is no guarantee that interference will not occur in a particular installation.

If this equipment does cause harmful interference to radio or television reception, which can be determined by turning the equipment off and on, the user is encouraged to try to correct the interference by one or more of the following measures:

- Reorient or relocate the receiving antenna.
- Increase the separation between the equipment and the receiver.
- Connect the equipment into an outlet on a circuit different from that to which the receiver is connected.
- Consult the dealer or an experienced radio/TV technician for help.

⚠ CAUTION

Changes or modifications not expressly approved by Leica Geosystems for compliance could void the user's authority to operate the equipment.

Labelling GS18



0014277_001

Model: GS18 S.No.:1579025
 Equip. No: 12345678 Art.No.: 848293
 Leica Geosystems AG, CH-9435 Heerbrugg
 Manufactured: 2017, Made in Switzerland
 Power: 15V nominal / 2.5 A max
 Contains: FCC-ID / IC
 RFD-BTWCO / 3177A-BTWCO



This device complies with part 15 of the FCC Rules. Operation is subject to the following two conditions:
 (1) This device may not cause harmful interference, and
 (2) this device must accept any interference received, including interference that may cause undesired operation.

Labelling GEB331

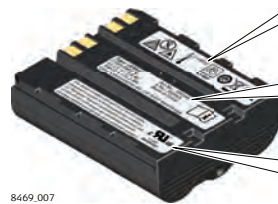

8469_007



Model/型號: GEB331 Art. No.: 799190
 Li-Ion Battery 二次電池/電池組
 額定電壓 1.2 V / 2.8 Ah S. No.: XXXXX
 1.5 A / 31.1 Wh 31 CR 19 / 66 R3C319 YL10456-16004
 Leica Geosystems AG, CH-9435 Heerbrugg Made in China 中國製造

This device complies with part 15 of the FCC Rules. Operation is subject to the following two conditions:
 (1) This device may not cause harmful interference, and
 (2) this device must accept any interference received, including interference that may cause undesired operation.



1.8

ISED Statements (EN/FR), Applicable in Canada

WARNING

This Class (B) digital apparatus complies with Canadian ICES-003.
 Cet appareil numérique de la classe (B) est conforme à la norme NMB-003 du Canada.

Canada Compliance Statement

This device contains licence-exempt transmitter(s)/receiver(s) that comply with Innovation, Science and Economic Development Canada's licence-exempt RSS(s). Operation is subject to the following two conditions:

1. This device may not cause interference.
2. This device must accept any interference, including interference that may cause undesired operation of the device.

Canada Déclaration de Conformité

L'émetteur/récepteur exempt de licence contenu dans le présent appareil est conforme aux CNR d'Innovation, Sciences et Développement économique Canada applicables aux appareils radio exempts de licence. L'exploitation est autorisée aux deux conditions suivantes:

1. L'appareil ne doit pas produire de brouillage;
2. L'appareil doit accepter tout brouillage radioélectrique subi, même si le brouillage est susceptible d'en compromettre le fonctionnement.

2

Description of the System

2.1

System Components

Main components

Component	Description
Instrument	To calculate a position from the computed ranges to all visible GNSS (Global Navigation Satellite System) satellites. To estimate a tilt compensated pole tip position by combining the GNSS position with attitude information from an Inertial Measurement Unit (IMU). To capture image groups with the camera and to use those captured images to calculate the 3D coordinates of points.
Web server	Web-based tool to preprogram the GNSS instrument.
Antenna	To receive the satellite signals from the GNSS satellites.
Leica Infinity	The office software including a series of help programs which support working with Leica instruments.

Instrument

Instrument	Description
GS18	GPS, GLONASS, BeiDou and GalileoGNSS receiver, multi-frequency, SBAS (EGNOS, WAAS, MSAS, GAGAN), code and phase, real-time capable, integrated Inertial Measurement Unit.

2.2

System Concept

2.2.1

Software Concept

Description

All instruments use the same software concept.

Software for all GS GNSS instruments

Software type	Description
GS firmware (GS_xx.fw)	This software covers all functions of the instrument. The Web server application is integrated into the firmware and cannot be deleted. The English language is integrated into the firmware and cannot be deleted.
Language software (WEB_LANG.sxx)	Numerous languages are available for the Web server application. The English language is the default language. One language is chosen as the active language.

Software upload



Uploading GS firmware can take some time. Ensure that the battery is at least 75% full before beginning the upload, and do not remove the battery during the upload process.

Software for	Description
All GS models	The software can be uploaded using the Leica Web server application or myWorld@Leica Geosystems.
	 Ensure that a Leica SD card is inserted into the GS instrument before starting the upload. Refer to 4.3 Working with the SD Card .

2.2.2

Power Concept

General

Use the batteries, chargers and accessories recommended by Leica Geosystems to ensure the correct functionality of the instrument.

Power options

Power for the instrument can be supplied either internally or externally.

Model	Power supply
Internally	One battery (GEB331) fits into the instrument.
Externally	GEB371 battery connected via a cable, or Car battery connected via a converter cable supplied by Leica Geosystems, or 10.5 V-28 V DC power supply via a converter cable supplied by Leica Geosystems, or 110 V/240 V AC to 12 V DC power supply unit, supplied by Leica Geosystems.



For permanent operations use **Uninterruptible Power Supply** units as a backup in a main power failure.

2.2.3

Data Storage Concept

Description

Data (Leica GNSS raw data and RINEX data) can be recorded on the SD card.

Memory device

SD card: The GS18 GNSS instrument has an SD card slot fitted as standard. An SD card can be inserted and removed.
Available capacity: 1 GB, 8 GB.



While other SD cards can be used, Leica Geosystems recommends to only use Leica industrial grade SD cards and is not responsible for data loss or any other error that can occur while using a non-Leica card.



Unplugging connecting cables, removing the data storage device or interrupting the power supply during the measurement can cause loss of data. Only remove the data storage device, unplug connecting cables or interrupt the power supply when the GS GNSS instrument is switched off.



SD cards can directly be used in an OMNI drive as supplied by Leica Geosystems. Other PC card drives can require an adaptor.

2.3

Container Contents

Container for GS instrument and accessories 1/2

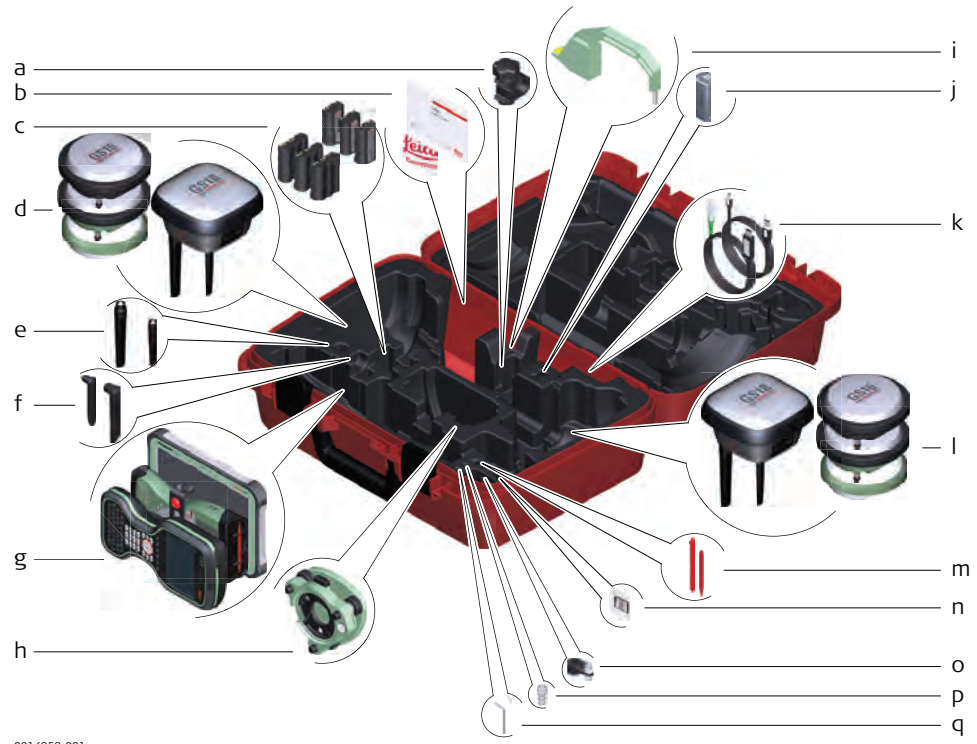

0014958.001

- a GHT63 clamp
- b Manuals and USB documentation card
- c GEB212 or GEB331 batteries
- d Antenna
- e GAT18, GAT27 or GAT28 mobile antenna
- f GAT21, GAT25 or GAT26 radio antenna
- g Field controller with holder or CS35 tablet
- h Tribrach
- i Height hook
- j USB stick
- k Cables
- l Antenna
- m Stylus
- n SD cards
- o GAD34 arm 3 cm
- p TNC QN-adaptor
- q Allen key and adjustment tool

**Container for GS
instrument and
accessories 2/2**



0014961.001

- a GHT36 base for telescopic rod
- b Antenna arm
- c GFU RTK modem
- d GAD32 telescopic rod
- e GAT1 or GAT2 radio antennas
- f GEB212 or GEB331 batteries
- g GRT146 or GRT247 carrier
- h GAD33 arm
- i GHT58 tripod bracket for GFU
- j External battery

Container for GS instrument and accessories

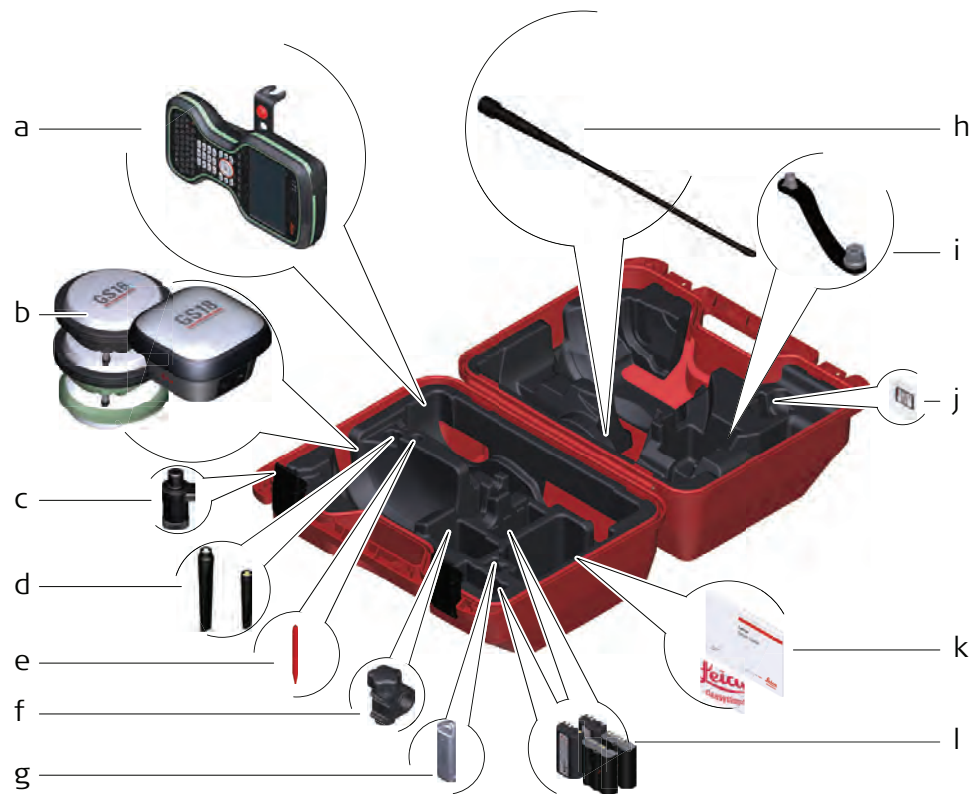

0014955_001

- a Field controller with holder
- b Antenna
- c CRP15, quick release adaptor for quick mounting and demounting the GS18 to the pole without screwing
- d GAT25, GAT26, GAT27 or GAT28 antenna
- e Stylus
- f GHT63 clamp
- g USB stick
- h GAT1 or GAT2 radio antennas
- i Antenna arm
- j microSD card including adapter or SD card
- k Manual & USB documentation card
- l GEB212 or GEB331 batteries

2.4

Instrument Components



The instrument can be preprogrammed using the Web server application running from the instrument on a web browser of a Windows device. Connect the instrument to a computer using a cable. Turn on the instrument by holding down the Power key for 2 s. A green blinking light at the connectivity and the storage LED indicates that the instrument powers up.

GS18 components



- a SMB-connector for external UHF antenna, only for models with UHF radio
- b SMB-connector for external LTE antenna
- c LEDs, ON/OFF button and Function button
- d Battery compartment with SD card and micro SIM card slot
- e LEMO port, serial, USB and external power
- f Antenna Reference Plane (ARP)



- a Camera (GS18 I)



A Bluetooth port is included inside all GS GNSS instruments enabling connectivity to the field controller.

3 User Interface

3.1 Keyboard

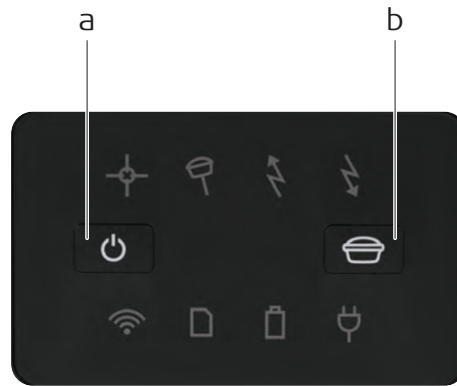

Keyboard GS18



0014280_001

- a ON/OFF button
- b Function button

ON/OFF button

Button	Function
ON/OFF	<p> If GS18 already off: Turns on GS18 when held for 2 s.</p> <p> While the GS18 is booting the Connectivity and Storage LED are flashing green. The Battery and or Power LEDs shine green or red depending on the power source and the battery status.</p> <hr/> <p>If GS18 already on: Turns off GS18 when held for 2 s.</p> <p> The Position LED shines orange. The Tilt and the Storage LEDs shine red. RTK Base and RTK Rover LEDs shine green. The Connectivity LED shines blue or green, depending on the connectivity. The Battery and Power LEDs shine green or red depending on the battery status.</p>

Function button

 All functions following described assume the GS18 is already on.



Button	Function
Function	<p> Press and hold button for <1 s.</p> <p>If the GS18 is in:</p> <ul style="list-style-type: none"> • base mode: The GS18 switches to be in rover mode. • rover mode and in static mode: No action. • rover mode and in kinematic mode: The GS18 switches to be in base mode.

Press and hold button for 3 s.

If the GS18 is in:

Button	Function
	<ul style="list-style-type: none"> base mode and a position is available, RTK OUT is configured: The RTK base LED flashes green for 2 s. The GS18 takes the next available position and updates the coordinates of the currently stored RTK base position. base mode and no position is available, no RTK OUT is configured: No action. rover mode: No action.
	<hr/> Press and hold button for 5 s. If the GS18 is in: <ul style="list-style-type: none"> base mode: No action. rover mode and RTK IN via Internet is configured: The RTK rover LED flashes green for 2 s. The GS18 will connect to the RTK base station or the Ntrip server configured. rover mode and RTK IN active and data being received via Internet: The RTK rover LED flashes green for 2 s. The GS18 will stop the RTK stream and disconnect to the RTK base station or (Ntrip) server. rover mode but RTK in not configured: No action.

Button combinations

Button	Function
ON/OFF 	Press and hold both buttons, release after 1 s.
Function 	The current almanacs stored on the GNSS instrument are deleted and new almanacs are downloaded. The Position LED flashes orange quickly three times. Press and hold buttons for 5 s. The Memory LED flashes red quickly three times. If inserted, the SD card of the GNSS instrument is formatted. The Memory LED continues to flash red as the SD card is formatted.
	<hr/> Press and hold buttons for 10 s. The System RAM on the GNSS instrument is formatted. Settings of all installed software will be deleted. After the formatting the System RAM, the GNSS instrument is turned off. Following LEDs flash simultaneously three times: <ul style="list-style-type: none"> Position LED: Orange Tilt LED: Red RTK Base and RTK Rover LEDs: Green
	<hr/> Press and hold buttons for 15 s.

Button	Function
	<p>The System RAM on the GNSS instrument is formatted. Settings of all installed software will be deleted. The registry of the GNSS instrument is deleted. Windows CE and communication settings will be reset to factory defaults. After deleting the registry, the GNSS instrument is turned off.</p> <p>Following LEDs flash simultaneously three times:</p> <ul style="list-style-type: none"> • Position LED: Orange • Tilt and Storage LED: Red • Connectivity LED: Blue • All other LEDs: Green
	<p>Press and hold buttons for >15 s.</p> <p>The GNSS instrument switches back to last operation mode.</p>

3.2

Operating Principles

Operating the instrument

The GS18 GNSS instrument is operated either by pressing its buttons (ON/OFF button, function button) or by the field controller.

Operation by buttons

The GS18 GNSS instrument is operated by pressing its buttons. Refer to [3.1 Keyboard](#) for a detailed description of the buttons and their function.

Operation by field controller

The GS18 GNSS instrument is operated by the field controller using the Captivate software. Refer to the User Manual of the field controller for a detailed description of the keys and their function.

Turn on GS18

To turn on the instrument press and hold the Power button for 2 s.

Turn off GS18

To turn off the instrument:

- press and hold the ON/OFF button for 2 s
- confirm to power down the instrument when exiting the software on the field controller

4 Operation

4.1 Equipment Setup

4.1.1 Setting up as a Post-Processing Base

Use The equipment setup described is used for static operations over markers.

Description The instrument can be programmed with the field controller before use which can then be omitted from the setup.



- The antenna is mounted directly using screw fitting. If using stub and adapter, procedures can vary slightly.
- When using the adapter and carrier, ensure that the antenna and the adapter assembly slide down the full length of the carrier stub. An incorrectly mounted antenna will have a direct effect on the results.



Use an external battery such as GEB371 to ensure operation for a full day.

Equipment setup

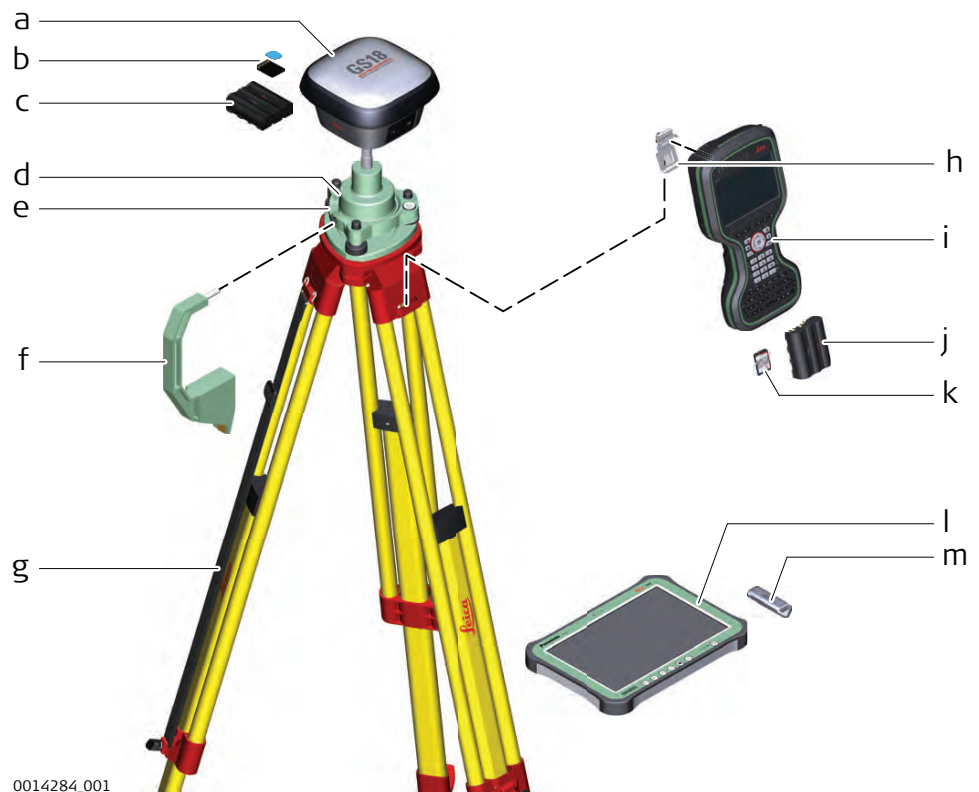

- a GS instrument
- b SD card
- c GEB331 battery
- d GRT146 carrier
- e Tribrach
- f Height hook
- g Tripod
- h Utility hook
- i CS20 field controller
- j GEB331 battery
- k SD card
- l CS35 tablet
- m USB stick

**Equipment setup
step-by-step**

1. Set up the tripod.
2. Mount and level the tribrach on the tripod.
3. Ensure that the tribrach is over the marker.
4. Place and lock the carrier in the tribrach.
5. Insert the data storage device and the batteries into the GS.
6. Screw the GS onto the carrier.
7. Check that the tribrach is still level.
8. Insert the data storage device and the battery into the field controller.
9. Switch on the field controller and connect it to the instrument if necessary.
10. To hang the field controller on the tripod leg, use the hook on the hand strap or use the utility hook. Refer to the User Manual of the field controller.
11. Insert the height hook into the carrier.
12. Measure the antenna height using the height hook.
13. Press the ON/OFF button on the instrument for at least 2 s to switch on the instrument.

4.1.2

Setting up as a Real-Time Base

Use

The equipment setup described is used for real-time base stations with the need of optimal radio coverage. Raw observation data can also be collected for post-processing.

Description

The GS18 instrument can be programmed with the field controller before use which can then be omitted from the setup.

The connection between GS18 and the field controller is made via Bluetooth.

The radio antenna (GAT28) is directly mounted downwards facing at the GNSS antenna. Alternatively, the radio antenna (GAT1/GAT2) can be mounted on the antenna arm (CA41) which clips to the GNSS antenna.



- The GNSS antenna is mounted directly using screw fitting. If using stub and adapter, procedures can vary slightly.
- When using the adapter and carrier, ensure that the antenna and the adapter assembly slide down the full length of the carrier stub. An incorrectly mounted antenna will have a direct effect on the results.
- Standard radio is used throughout the instructions. Digital cellular phones can also be used but the setup can differ slightly.



Use an external battery such as GEB371 to ensure operation for a full day.

Equipment setup - GS18 cellular or GS18 UHF

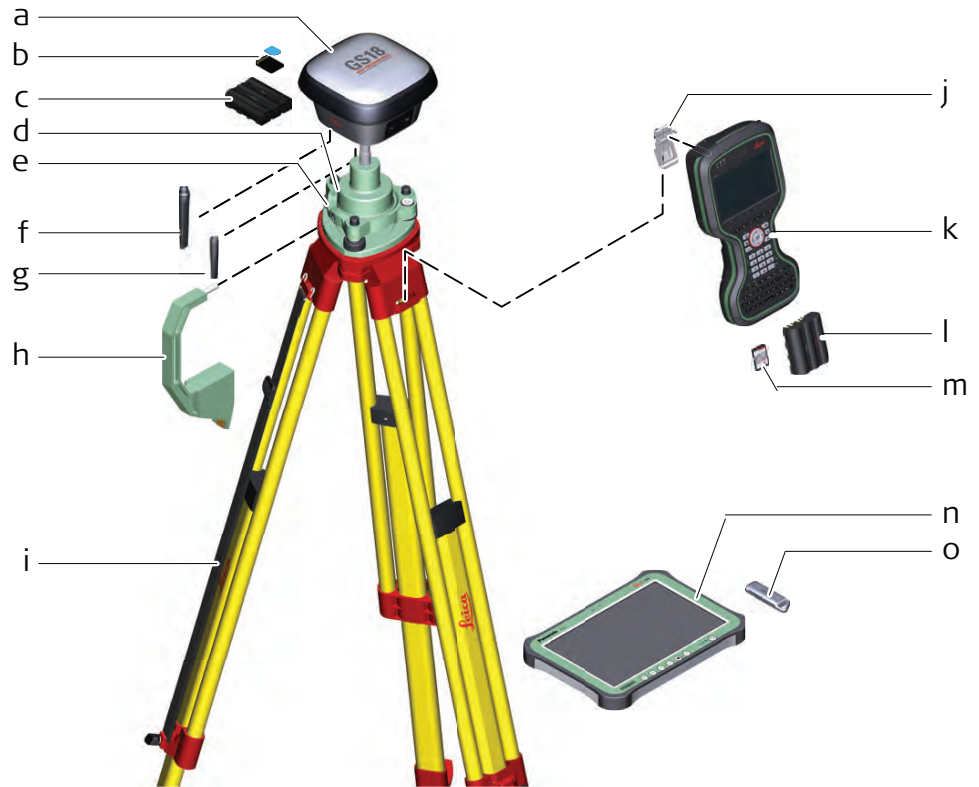

0014285.001

- a GS instrument with integrated cellular modem or UHF (transmit) modem
- b SD card and micro SIM card
- c GEB331 battery
- d GRT146 carrier
- e Tribrach
- f GAT28 radio antenna, for UHF use only
- g GAT27 LTE antenna
- h Height hook
- i Tripod
- j Utility hook
- k CS20 field controller
- l GEB331 battery
- m SD card
- n CS35 tablet
- o USB stick

Equipment setup

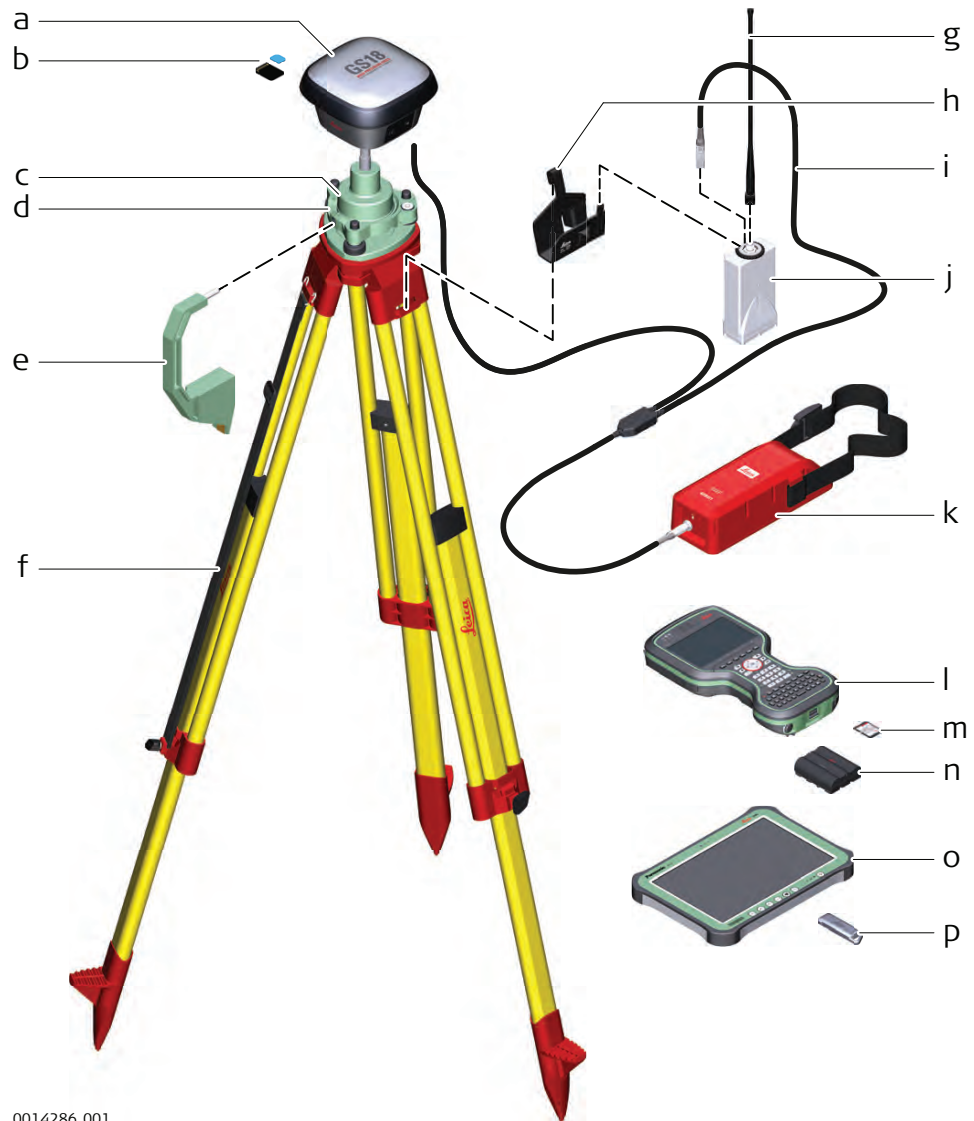

0014286_001

- a GS instrument
- b SD card and micro SIM card
- c GRT146 carrier
- d Tribrach
- e Height hook
- f Tripod
- g GAT1/GAT2 radio antenna
- h GHT58 tripod bracket
- i GEV264 Y-cable
- j GFU radio modem
- k GEB371 external battery
- l CS20 field controller
- m SD card
- n GEB331 battery
- o CS35 field controller
- p USB stick

Equipment setup step-by-step

1.	Set up the tripod.	
2.	Mount and level the tribrach on the tripod.	
3.	Ensure that the tribrach is over the marker.	
4.	Place and lock the carrier in the tribrach.	
	GS18	GS with external RTK device
5.	Insert the data storage device and the batteries into the GS18.	
6.	Screw the GS18 onto the carrier.	
7.	Check that the tribrach is still level.	
8.	-	Hang the external battery onto a tripod leg.
9.	-	Hang the tripod bracket onto a tripod leg and attach the radio housing onto the tripod bracket.
10.	Connect the UHF or LTE antenna to the GS18.	Connect the GEV264 cable to the GS18, to the external battery and to the radio housing.
11.	Insert the data storage device and the battery into the field controller.	
12.	Connect the field controller to the instrument if necessary.	
13.	To hang the field controller on the tripod leg, use the hook on the hand strap or use the utility hook. Refer to the User Manual of the field controller.	
14.	Insert the height hook into the carrier.	
15.	Measure the antenna height using the height hook.	
16.	Press the ON/OFF button on the instrument for at least 2 s to switch on the instrument.	

4.1.3

Setting up as a Real-Time Rover

Use

The equipment setup is used for real-time rover with extended periods of use in the field.

Description

Connections are made to the GNSS antenna, radio antenna and field controller.

The field controller is fixed to the pole with the GHT63. Connection between the GS18 instrument and the field controller is made through Bluetooth.



- The antenna is mounted directly using screw fitting. If using stub and adapter, procedures can vary slightly.
- When using the pole with stub, ensure that the antenna and the screw-to-stub adapter slide down the full length of the stub before tightening the locking ring. An incorrectly mounted antenna will have a direct effect on the results.
- Carbon fibre poles are used since they are recommended for automatic tilt compensated measurements. For applications without tilt compensation, they can be replaced with their aluminium equivalent without any changes to these instructions.
- Standard radio is used throughout the instructions. Digital cellular phones can also be used but the setup can differ slightly.

Equipment setup - GS18 LTE

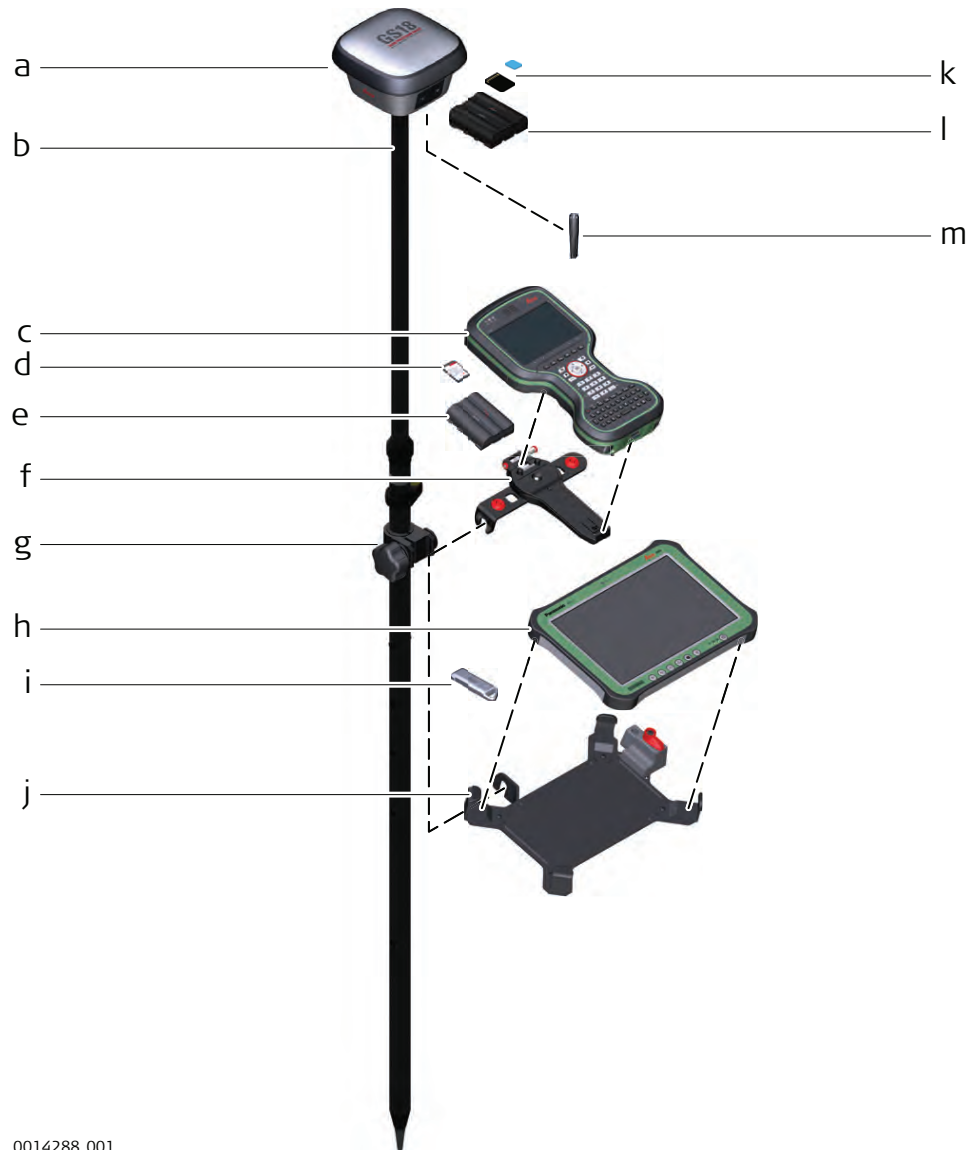

- a GS instrument
- b GLS30 carbon fibre pole
- c CS20 field controller
- d SD card for CS20
- e GEB331 battery
- f GHT66 holder
- g GHT63 pole clamp
- h CS35 tablet
- i USB stick
- j GHT78 holder
- k SD card and micro SIM card for GS18
- l GEB331 battery
- m GAT27 LTE external antenna

**Equipment setup -
GS18 UHF**

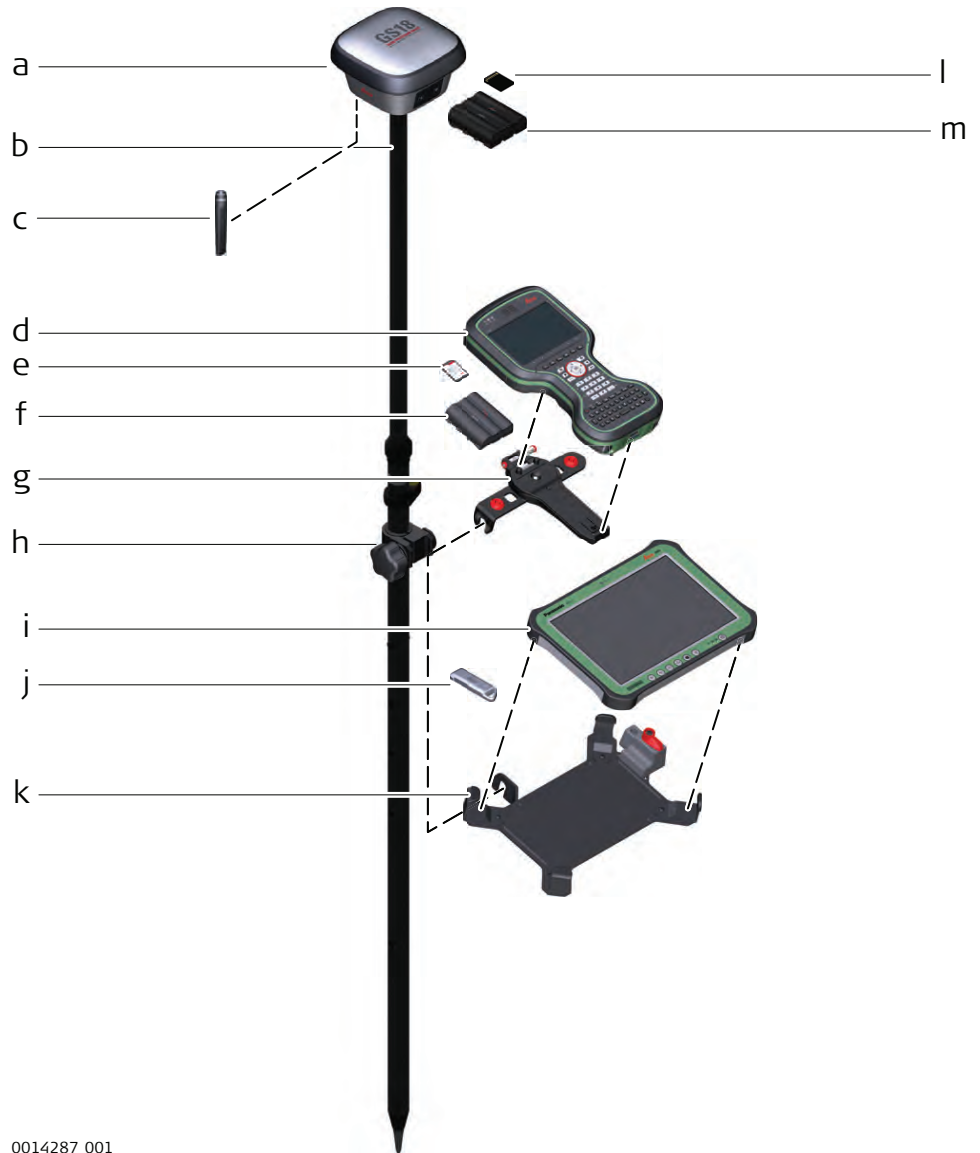

0014287_001

- a GS instrument with integrated UHF radio modem
- b GLS30 carbon fibre pole
- c GAT28 radio antenna
- d CS20 field controller
- e SD card for CS20
- f GEB331 battery
- g GHT66 holder
- h GHT63 pole clamp
- i CS35 tablet
- j USB stick
- k GHT78 holder
- l SD card for GS18
- m GEB331 battery

Equipment setup step-by-step

1. Attach the GHT66 for CS20 holder to the pole.
2. Insert the data storage device and the battery into the field controller.
3. Clip the field controller into the holder and lock it by pushing the locking pin into the locked position.
4. Press ON/OFF button on the field controller to switch on.
5. Insert the data storage device and the batteries into the GS18.
6. Press ON/OFF button on the GS18 to switch on.
7. Screw the GS18 to the top of the pole.
8. The field controller and GS18 are connected via Bluetooth.

4.1.4

Fixing the Field Controller to a Holder and Pole



This chapter is valid for all holders.

Components of the GHT66 Holder

The GHT66 holder consists of the following components:

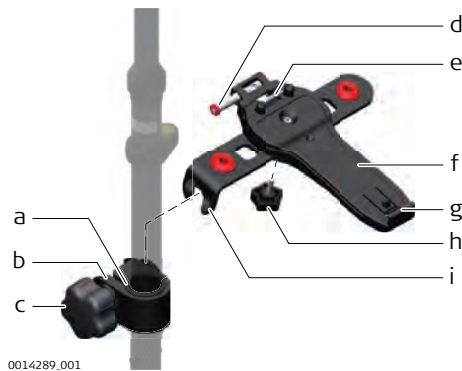

0014289_001

GHT63 clamp

- a Plastic sleeve
- b Pole clamp
- c Clamp bolt

GHT66 holder

- d Locking pin
- e Top clip
- f Mounting plate
- g Bottom clip
- h Tightening screw
- i Mounting arm

Fixing the field controller and GHT66 to a pole step-by-step



For an aluminium pole, fit the plastic sleeve to the pole clamp.

1. Insert the pole into the clamp hole.
2. Attach the holder to the clamp using the clamp bolt.

3. Adjust the angle and the height of the holder on the pole to a comfortable position.
4. Tighten the clamp with the clamp bolt.

5. Before placing the CS field controller onto the mounting plate, ensure that the locking pin is put into the unlocked position. To unlock the locking pin, push the locking pin to the left.

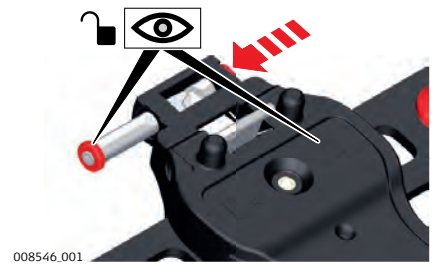

6. Hold the CS field controller above the holder and lower the end of the CS field controller into the mounting plate.

7. Apply slight pressure in a downward direction and then lower the top part of the CS field controller until the unit is clicked into the holder. The guides of the mounting plate aid in this action.



8. After the CS field controller is placed onto the mounting plate, ensure that the locking pin is put into the locked position. To lock the locking pin, push the locking pin to the right.

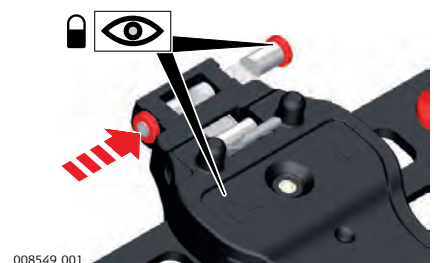

Detaching the field controller from a pole step-by-step

1. Unlock the locking pin by pushing the locking pin to the left of the mounting plate.
2. Place your palm over the top of the field controller.
3. While in this position, lift the top of the field controller from the holder.



4.1.5

Connecting to a Personal Computer

Description

Leica USB drivers support Windows 7, Windows 8 (8.1) and Windows 10 operating systems.

Cables

Leica USB drivers support:

Name	Description
GEV234	USB data cable, 1.65 m, connects CS to GS or CS to PC (USB)
GEV261	Y-cable, 1.8 m, connects instrument to PC – battery

Uninstalling the previous drivers



Skip the following steps if you have never installed Leica USB drivers before.

If older drivers were previously installed on the PC, follow the instructions to uninstall the drivers prior the installation of the new drivers.

1. Connect your instrument to the PC via cable.
2. On your PC, select to **Control Panel > Device Manager**.
3. In **Network Adapters**, right-click on **Remote NDIS based LGS...**
4. Click on **Uninstall**.

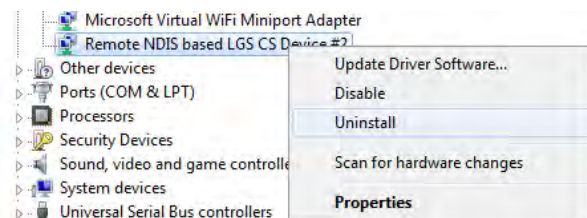

5. Set **Delete the driver...** as checked. Press **OK**.



Install Leica USB drivers

1. Start the PC.
2. Run the **Setup_Leica_USB_XXbit.exe** to install the drivers necessary for Leica devices. Depending on the version (32bit or 64bit) of the operating system on your PC, you have to select between the three setup files following:
 - Setup_Leica_USB_32bit.exe
 - Setup_Leica_USB_64bit.exe
 - Setup_Leica_USB_64bit_itanium.exe
 - ☞ To check the version of your operating system, go to **Control Panel > System > System type**.
 - ☞ The setup requires administrative privileges.
 - ☞ The setup has to be run only once for all Leica devices.
3. The **Welcome to InstallShield Wizard for Leica GS, TS/TM/MS, CS and GR USB drivers** window appears.
 - ☞ Ensure that all Leica devices are disconnected from your PC before you continue!

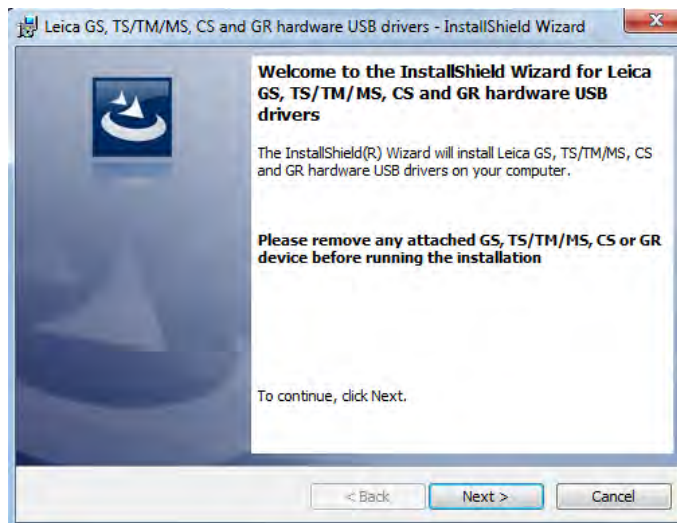

4. Click **Next>**.
5. The **Ready to Install the Program** window appears.

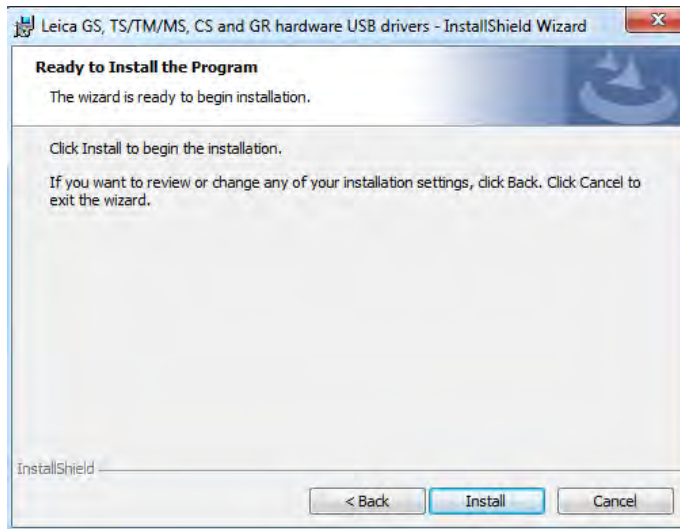

6. Click **Install**. The drivers will be installed on your PC.
7. The **InstallShield Wizard Completed** window appears.
8. Click **Finish** to exit the wizard.

Connect to PC via USB cable step-by-step

1. Start the PC.
2. Plug the cable into the instrument.
3. Turn on the instrument.
4. Plug the cable into the USB port of the PC.
5. Press the Windows Start button at the bottom left corner of the screen.
6. Type the IP address of the device into the search field.
 - \\192.168.254.1\ for field controller
7. Press **Enter**.
A file browser opens. You can now browse within the folders on the instrument.

4.1.6

Connecting to the Web Server

Description

The Web server is a web-based tool to view the status of and configure the GNSS instruments. The Web server application is integrated into the GS firmware and cannot be deleted.

Accessing the Web server via cable step-by-step

Action

1. Start the PC and turn on the GS instrument.
 Instead of connecting to your PC, you can connect your GS instrument to the field controller.
2. Connect the GS instrument with the GEV234 cable to the PC. Refer to [4.1.5 Connecting to a Personal Computer](#).

Action

3. Double-Click the **Configure GS connection** shortcut from the desktop of your PC. The GS network adapter is configured with IP address: 192.168.254.1. A DOS window appears when the configuration was successful. Press any key to exit the DOS window. The **Configure GS connection** shortcut disappears from the desktop.
4. Start the web browser of your PC.
5. Type in **http://192.168.254.2** and press enter to access the web server of GS instrument.

Accessing the Web server via Bluetooth step-by-step

To access the Web server the tasks following have to be done:

- Configure the PC's Bluetooth device
- Establish a Bluetooth connection between PC and GS
- Accessing the Web server

Configuring the PC's Bluetooth device

Action



1. Start your PC.
2. Activate the Bluetooth device of your PC.
3. Go **Start**⇒**Settings**⇒**Network Connections**.
4. Double-click **Bluetooth** from the **LAN or High-Speed Internet** device list. The **Bluetooth Properties** windows is started.
5. In the **General** page, select **Internet Protocol (TCP/IP)** from the list and click **Properties**. The **Internet Protocol (TCP/IP) properties** windows is started.



This procedure has to be done only once.

Establishing a Bluetooth connection between PC and GS instrument

Action

1. Start the PC and turn on the GS instrument.
 Instead of connecting to your PC, you can connect your GS instrument to the field controller. In this case, turn on the field controller, start Captivate and establish a Bluetooth connection to the GS instrument.
2. Run the Bluetooth software and start the **Bluetooth Setup Wizard**.
3. Click **Next**. The **Bluetooth Device Selection** will be started and an automatic search will be done.
4. Select the shown GS instrument and click **Next**. The Bluetooth Security Setup is started.
5. Type in **0000** as **Bluetooth security code** and click **Pair Now**. The pairing procedure will be done and the Bluetooth Service Selection is started.
6. Highlight **Personal Ad-hoc Network** and check the checkbox for Personal Ad-hoc Network.
 Do not select **Serial Port** as service.

Action	
7.	Click Next . The Bluetooth Setup Wizard Completion Page is started.
8.	Type in a name for your GS instrument and click Finish to complete the Bluetooth Setup Wizard .
	This procedure has to be repeated for every GS instrument you want to connect to.

Accessing the Web server

Action	
1.	Start the web browser on your PC/field controller.
	Ensure that your GS instrument is still running and the Bluetooth connection between PC/field controller and GS is established.
2.	Type in 192.168.253.2 . The Web server is started. You will see the home functions following: <ul style="list-style-type: none"> • Go to Work! <ul style="list-style-type: none"> • To select and start the Wake-up application. • Current Status <ul style="list-style-type: none"> • To access GNSS information of the GS as well as the instrument firmware. • Instrument <ul style="list-style-type: none"> • To access configuration settings for the GS. • User <ul style="list-style-type: none"> • To upload and activate firmware, licence keys and languages.

4.2

Batteries

4.2.1

Operating Principles

First-time use/ charging batteries

- The battery must be charged before using it for the first time because it is delivered with an energy content as low as possible.
- The permissible temperature range for charging is from 0 °C to +40 °C/+32 °F to +104 °F. For optimal charging, we recommend charging the batteries at a low ambient temperature of +10 °C to +20 °C/+50 °F to +68 °F if possible.
- It is normal for the battery to become warm during charging. Using the chargers recommended by Leica Geosystems, it is not possible to charge the battery once the temperature is too high.
- For new batteries or batteries that have been stored for a long time (> three months), it is effectual to make only one charge/discharge cycle.
- For Li-Ion batteries, a single discharging and charging cycle is sufficient. We recommend carrying out the process when the battery capacity indicated on the charger or on a Leica Geosystems product deviates significantly from the actual battery capacity available.

Operation/discharging

- The batteries can be operated from -20 °C to +55 °C/-4 °F to +131 °F.
- Low operating temperatures reduce the capacity that can be drawn; high operating temperatures reduce the service life of the battery.

4.2.2

Battery for GS18



The SIM card size must be a micro SIM (3FF) .

The SIM card must be inserted in the correct way as depicted on the GS18 housing.

Using a SIM card adapter might damage the SIM card tray of the GS18.

Change battery step-by-step



1. Push the slide fastener of the battery compartment in the direction of the arrow with the open-lock symbol. Remove the cover.
2. To remove the battery, push the retaining clip upwards. This releases the battery from its fixed position.
3. Remove the battery.
4. To insert the battery, slide the battery into the battery compartment with the battery contacts facing downwards. Push the battery into the compartment so that it locks into position.
5. Insert the cover of the battery compartment into the compartment.
6. Push the slide fastener in the direction of the arrow with the close-lock symbol.

4.3

Working with the SD Card



- Keep the card dry.
- Use it only within the specified temperature range.
- Do not bend the card.
- Protect the card from direct impacts.



Failure to follow these instructions could result in data loss and/or permanent damage to the card.

Insert a SD card and micro SIM card step-by-step



Removing the SD card or micro SIM card while the GS18 is turned on can cause loss of data. Only remove the SD card or micro SIM card or unplug connecting cables when the GS18 is switched off.

The SD card and micro SIM card are inserted into a slot inside the battery compartment of the instrument.

1. Push the slide fastener of the battery compartment in the direction of the arrow with the open-lock symbol.
2. Remove the cover from the battery compartment.
3. Slide the SD card and micro SIM card with the logo facing upwards firmly into the slot until it clicks into position.
4. Insert the cover of the battery compartment into the compartment.
5. Push the slide fastener in the direction of the arrow with the close-lock symbol.

4.4

Working with the Tilt Compensation

Description

The pole can be held in a slanting position over the point to be measured without checking the circular bubble on the pole.

Measurements are reliable and accurate even if the pole is not levelled as the tilt values are calculated by an Inertial Measurement Unit. Tilt values contain information about the 3D position of the pole.

The measurements are immune to magnetic disturbances as there is no magnetometer used.

Tilt compensation also works with Navigated and Code solutions. High accuracy positions are recommended to speed up the tilt compensation initialization.

Tilt compensation is turned off when RINEX logging is on.

When measuring a point, the pole tip must be stable on the point while the pole should be in slight movement. Tilt compensation is indicated by an icon and the Tilt LED and is maintained by natural pole movement, for example while moving to the next point to be measured.



Advantages:

- No need to level the pole
- Faster surveying procedure

Diagram



Tilt compensation step-by-step

Action	Result
 A GS18 must be configured as real-time rover and connected to a CS20 or CS35.	
1. Leica Captivate - Home: Settings\GS Sensor\Tilt compensation	
2. Tilt Compensation Use tilt compensation: Check box checked. Set Use tilt compensator to: Compensate & store tilt.	
3. OK	
 Move the antenna for initialisation. Walking to the survey mark is sufficient. A message and a voice prompt indicate that the tilt compensation is being applied.	

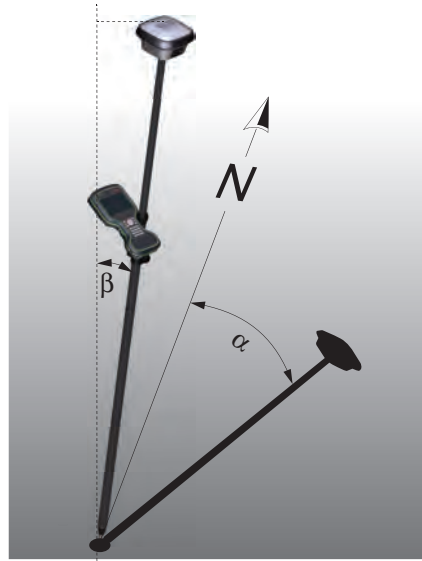
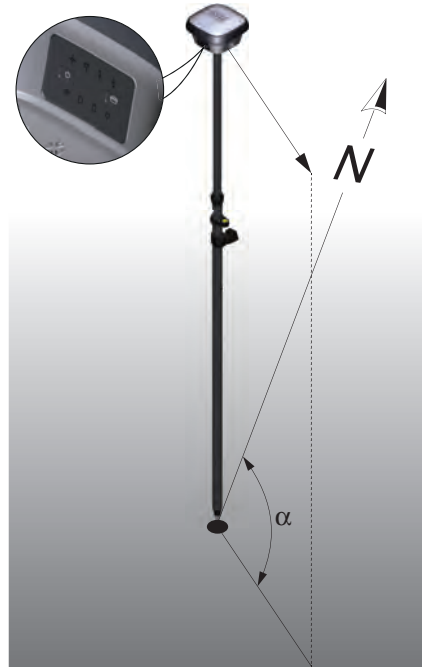
Action	Result
<p>☞ The LEDs on the GS18 and the green background of the position icon on the CS20 or CS35 indicate when a tilt compensated measurement is possible. Refer to 4.6 LED Indicators on GS18.</p>	
<p>4. For an overview of the current position in the survey area Click the GS position icon. Select Current position.</p>	
<p>5. Current GS position, Tiltpage The fields are updated according to the setting for GS position update rate in Screen, Audio & Text Input.</p>	 <p>0014298.002</p> <p>α Tilt β Direction of tilt</p>
	 <p>0014307.001</p> <p>α GS heading</p>

Action	Result
--------	--------

6. **For an overview of the current position in the survey area**

Use the 3D viewer with dxf data or a background image:

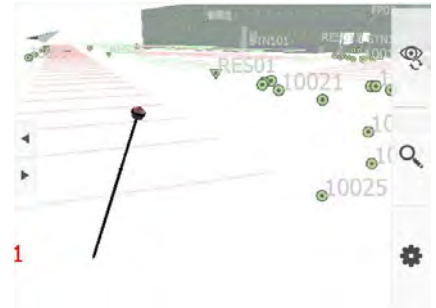

7. **Measure points**

Leica Captivate - Home: Measure

The position of the tilted GS18 is shown in the 3D viewer.

**Measure
Stop
Store**



Application example:

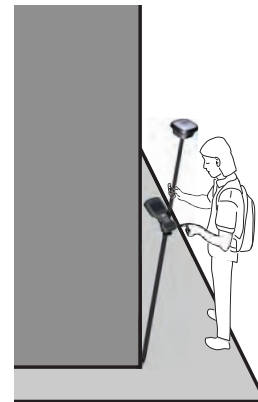

0014297_001

8. **Stake points**

Leica Captivate - Home: Stake points

The position of the tilted GS18 is shown in the 3D viewer.

9. Stake out the point. The values are valid for the tip of the pole.

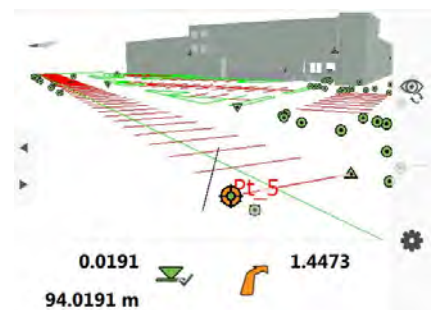

4.5

Working with the GS imaging App

Description

The camera can be used to capture images of an object of interest.

In respect to the user, the camera needs to be directed toward the left or the right side, so that it always faces the object of interest while walking along it.

To assure a good visual overlap of the images, the system captures the images with a rate of 2 Hz.

In order to get the best accuracy of point coordinates computed from the images, the images within one sequence should be captured along a U-shaped trajectory.

The images captured within one sequence will be stored as an image group.

The coordinates of any characteristic point captured in the images can be computed right away. One point needs to be picked manually in one image. The algorithm will automatically find the picked point in other images from the image group. The algorithm will select and use the images that are the most optimal for the calculation of the 3D position of the point.

Advantages:

- No need to measure each point individually with the pole tip of the GS sensor
- No need to physically access the points
- Capture images of the areas with weak or no satellite signal

Diagram

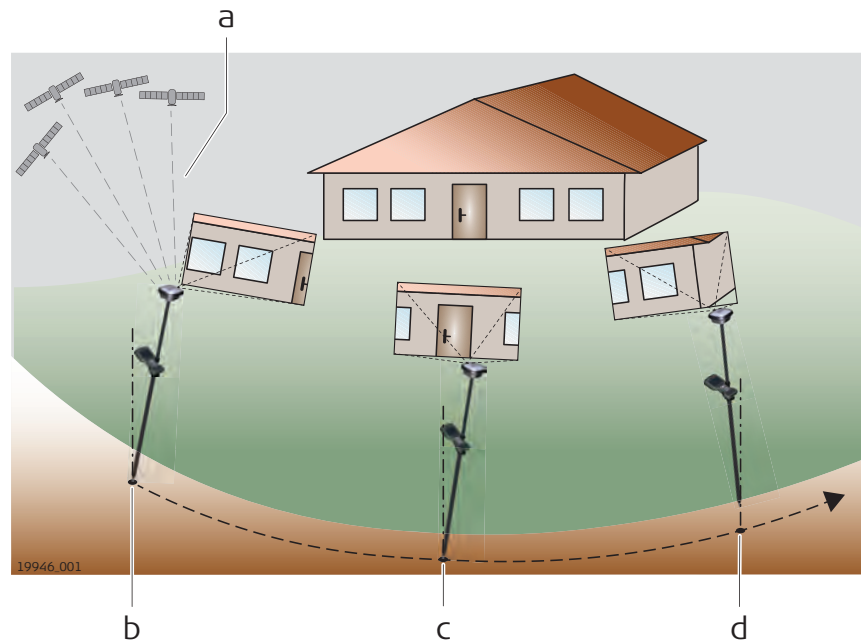

- a GNSS signal
- b Position of captured image i
- c Position of captured image i+1
- d Position of captured image i+2

Capturing an image group step-by-step



GS18 I is ready to capture an image group when all of the following conditions are fulfilled:

- The GS18 I must be configured as real-time rover and connected to a CS20 LTE or CS35 via cable or WLAN.
- The live video stream is visible.
- The tilt compensation is initialised.
- The 3D coordinate quality value is better than 10 cm.

Action	Result
1. Leica Captivate - Home: GS imaging\Capture image group	
2. Start Walk along the object of interest while the camera is directed toward the left or the right side in respect to the user. Stop Wait until the image processing has been finished. Store Capturing time The value indicates how much time has passed since the capturing of images was started. The capturing time is limited to 60 seconds. Number of images The value indicates the number of images that were captured within the image group	The capturing time increases constantly during the capturing. After 60 seconds, the capturing stops automatically. The number of images will be shown after the capturing is stopped.
3. Image group quality The value indicates the expected quality of a point measurement inside the image group	The quality will be shown after the capturing is stopped.









Measuring in images step-by-step



At least one image group must be stored within the active job.

1. **Leica Captivate - Home: GS imaging\Measure in images.**
2. Select an image group.
3. Pick a characteristic point in the image.
The picked point will be marked with the symbol  in the image.



Action	Result
<p> The snapping tool option can be used to automatically snap the point to the closest corner point.</p>	
<p>4. Measure</p>	
<p>For editing a measurement</p>	
<p> If an image was used for the calculation of the 3D coordinates of the picked point, the symbol  will appear in the selected image.</p>	
<p> If an image was not used for the calculation of the 3D coordinates of the picked point, the symbol  will appear in the selected image. The symbol marks the approximate position of the measured point in the selected image.</p>	
<p>5. To remove an image from the measurement, select the image with Previous or Next and press Remove.</p>	<p>The coordinates and its CQ values will be re-calculated automatically after the image has been removed from the measurement.</p>
<p>6. To add an image to the measurement, select the image with Previous or Next. Pick the point in this image and press Add. The image will be added to the measurements.</p>	<p>The coordinates and its CQ values will be re-calculated automatically after the image has been added to the measurement.</p>
<p>7. Store When the point is stored, the point symbol appears in all images of the image group.</p>	

4.6

LED Indicators on GS18

LED indicators

Description

The GS18 instrument has **L**ight **E**mitting **D**iode indicators. They indicate the basic instrument status.

Diagram

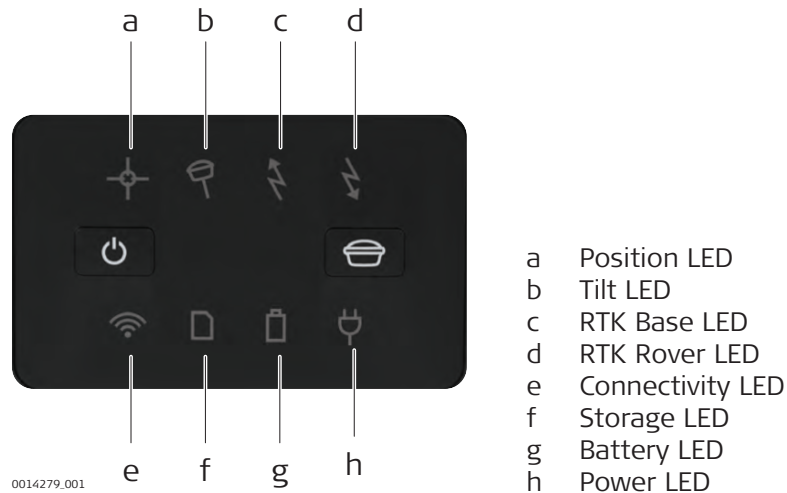

Description of the LEDs

LED	LED Status	Status of the Instrument
Position LED	off	No satellites are tracked or GS18 is switched off.
	flashing orange	Satellites are tracked, a position is not yet available.
	orange	A navigated position is available.
	flashing green	A code-only position is available. SmartLink is converging. SBAS correction is used.
	green	A fixed RTK position is available, including xRTK. SmartLink has converged.
Tilt LED	off	GS18 is not powered. Tilt functionality is unavailable or switched off.
	green	Tilt compensation is activated, compensation values are stored. Tilt compensation is being applied.
	red	Tilt compensation is activated, but currently not being applied
	flashing red	Undefined problem with tilt compensation
RTK Base LED	off	GS18 is in RTK rover mode or GS18 is switched off.
	green	GS18 is in base mode, no RTK data is transmitted

LED	LED Status	Status of the Instrument
	flashing green	GS18 is in base mode, RTK data is transmitted to the selected port. Rate according to RTK base setting.
RTK Rover LED	off	GS18 is in RTK base mode or GS18 is switched off.
	green	GS18 is in rover mode, no RTK data is received via selected port.
	flashing green	GS18 is in rover mode, RTK data is received via selected port. Rate according to received correction data.
Connectivity LED	off	GS18 is not powered or module is not ready.
	green	Bluetooth is in data mode and ready for connecting.
	blue	Bluetooth has connected.
Storage LED	off	No SD card is inserted or GS18 is switched off.
	green	SD card is inserted but no raw data is being logged.
	flashing green	Raw data is being logged. More than 50 MB of memory space is available on the SD card.
	red	Less than 50 MB of memory space is available on the SD card.
	flashing red	Raw data is being logged but less than 50 MB of memory space left on the SD card.
	fast flashing red	SD card is full or no SD card is inserted while raw data logging is configured. No raw data can be logged.
Battery LED	off	Battery is not connected, flat or GS18 is switched off.
	green	Power is 21% - 100%.
	flashing green	Battery is inserted. External power is connected.
	red	Power is 20% - 11%. The remaining time for which enough power is available depends on the type of survey, the temperature and the age of the battery.
	flashing red	Battery is inserted with less than 20% power remaining. External power is connected.
	fast flashing red	Power is low (<10%).
Power LED	off	External battery is not connected or flat or no external power supply is connected or GS18 is switched off.
	green	External power is 21% - 100%.
	red	External power is 20% - 11%.

LED	LED Status	Status of the Instrument
	flashing red	External power is low (<10%).

4.7

Guidelines for Correct Results with GNSS Surveys

Undisturbed satellite signal reception

Successful GNSS surveys require undisturbed satellite signal reception, especially at the instrument which serves as a base. Set up the instrument in locations which are free of obstructions such as trees, buildings or mountains.

Steady instrument for static surveys

For static surveys, the instrument must be kept perfectly steady throughout the whole occupation of a point. Place the instrument on a tripod or pillar.

Centred and levelled instrument

Centre and level the instrument precisely over the marker.

Tilt compensation for kinematic surveys

For stakeout and surveys with instantaneous point measurement, auto points or point measurements with short occupation time, tilt compensation is applied. The pole tip can be placed on the marker, while the antenna does not have to remain level and steady. The status of the tilt compensation is indicated by an icon and the Tilt LED.

5 Care and Transport

5.1 Transport

Transport in the field	<p>When transporting the equipment in the field, always make sure that you</p> <ul style="list-style-type: none">• either carry the product in its original container,• or carry the tripod with its legs splayed across your shoulder, keeping the attached product upright.
Transport in a road vehicle	<p>Never carry the product loose in a road vehicle, as it can be affected by shock and vibration. Always carry the product in its container and secure it.</p> <p>For products for which no container is available use the original packaging or its equivalent.</p>
Shipping	<p>When transporting the product by rail, air or sea, always use the complete original Leica Geosystems packaging, container and cardboard box, or its equivalent, to protect against shock and vibration.</p>
Shipping, transport of batteries	<p>When transporting or shipping batteries, the person responsible for the product must ensure that the applicable national and international rules and regulations are observed. Before transportation or shipping, contact your local passenger or freight transport company.</p>

5.2 Storage

Product	<p>Respect the temperature limits when storing the equipment, particularly in summer if the equipment is inside a vehicle. Refer to 6 Technical Data for information about temperature limits.</p>
Li-Ion batteries	<ul style="list-style-type: none">• Refer to 6 Technical Data for information about storage temperature range.• Remove batteries from the product and the charger before storing.• After storage recharge batteries before using.• Protect batteries from damp and wetness. Wet or damp batteries must be dried before storing or use.• A storage temperature range of 0 °C to +30 °C / +32 °F to +86 °F in a dry environment is recommended to minimize self-discharging of the battery.• At the recommended storage temperature range, batteries containing a 40% to 50% charge can be stored for up to one year. After this storage period the batteries must be recharged.

5.3 Cleaning and Drying

Product and Accessories	<ul style="list-style-type: none">• Use only a clean, soft, lint-free cloth for cleaning. If necessary, moisten the cloth with water or soapy water. Do not use other liquids; these may attack the product surface.
Damp products	<p>Dry the product, the transport container, the foam inserts and the accessories at a temperature not greater than 40 °C [104 °F] and clean them. Remove the battery cover and dry the battery compartment. Do not repack until everything is dry. Always close the transport container when using in the field.</p>

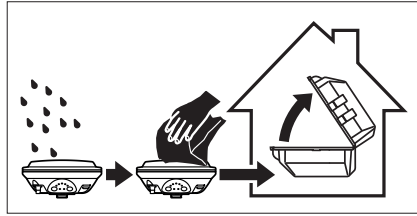

Cables and plugs

Keep plugs clean and dry. Blow away any dirt lodged in the plugs of the connecting cables.

Connectors with dust caps

Wet connectors must be dry before attaching the dust cap.

6 Technical Data

6.1 GS18 Technical Data

6.1.1 Tracking Characteristics

Satellite reception Multi-frequency

Instrument channels  Depending on the satellite systems and signals configured, a maximum number of 555 channels is allocated.

Supported signals

System	Signal
GPS	L1, L2, L2C, L5
GLONASS	L1, L2, L2C, L3*
Galileo	E1, E5a, E5b, AltBOC, E6*
BeiDou	B1I, B2I, B2a, B3I
QZSS	L1, L2C, L5, L6*
NavIC	L5
SBAS (WAAS, EGNOS, MSAS, GAGAN) Terrastar	L-band

* GLONASS L3, Galileo E6 and QZSS L6 will be provided through future firmware upgrade.

 Carrier phase and code measurements on L1, L2 and L5 (GPS) are fully independent with AS on or off.

 Support of NavIC L5 is incorporated and will be provided through future firmware upgrade.

6.1.2 Accuracy

 Accuracy is dependent upon various factors including the number of satellites tracked, constellation geometry, observation time, ephemeris accuracy, ionospheric disturbance, multipath and resolved ambiguities.

The following accuracies, given as **root mean square**, are based on measurements processed using Leica Infinity and on real-time measurements.

The use of multiple GNSS systems can increase accuracy by up to 30% relative to GPS only.

Differential code

The baseline precision of a differential code solution for static and kinematic surveys is 25 cm.

Differential phase in post-processing

Type	Horizontal	Vertical
Static and rapid static	3 mm + 0.5 ppm	5 mm + 0.5 ppm
Kinematic	8 mm + 1 ppm	15 mm + 1 ppm

Type	Horizontal	Vertical
Static with long observations	3 mm + 0.1 ppm	3.5 mm + 0.4 ppm

Differential phase in real-time

Type	Horizontal	Vertical
Single Baseline (<30 km)	10 mm + 1 ppm	20 mm + 1 ppm
Network RTK	10 mm + 0.5 ppm	20 mm + 0.5 ppm

Tilt

Tilt compensated in real-time
 Additional Hz pole tip uncertainty:
 Typically less than 8 mm + 0.4 mm/° tilt down to 30° tilt for topographic points (not for static control points)

Imaging

Typically 2 cm to 4 cm (2D) within the distance of 2 m to 10 m between the camera and the object
 The accuracy depends on the prevailing GNSS accuracy and the type of the trajectory.
 A curve in the trajectory increases the accuracy of an image point measurement.

6.1.3

Technical Data

Dimensions

Height: 0.109m
 Diameter: 0.190 m

Weight

Instrument weight without battery, SIM card and SD card:

Type	Weight [kg]/[lbs]
GS18 I	1.25/2.75
GS18 T	1.23/2.71

Recording

Data (Leica GNSS raw data and RINEX data) can be recorded on the SD card.
 1 GB is sufficient for over 1 year of raw data logging based on logging every 15 s from an average of 15 satellites.

Power

Power consumption: Radio excluded: 3.5 W typically, 300 mA (with external battery), 320 mA (with internal battery)
 External supply voltage: Nominal 12 V DC (---, GEV71 car battery cable to a 12 V car battery), voltage range 12 V-24 V DC

Internal battery

Type	Battery	Voltage	Capacity	Operating time, typical*
GEB331	Li-Ion	11.1 V	2.8 Ah	8 h

* Operating time depends on use of wireless communication devices.

External battery

Type	Battery	Voltage	Capacity
GEB371	Li-Ion	13 V	16.8 Ah

Operating times

The given operating times are valid for

- GS18: instrument; one fully charged GEB331 battery.
- Room temperature; operating times will be shorter when working in cold weather.

Type	Operating time	
Static	8 h continuously	
Rover	with cellular modem	6 h continuously
	with radio modem	7 h continuously
Base	with cellular modem	6 h continuously
	with radio modem	5 h continuously
	1 W output power	

Electrical data

Type	GS18	
Voltage	-	
Current	-	
GNSS Signal	Frequency	
GPS L5	1176.4500 MHz	✓
Galileo E5a		
BeiDou B2a		
Galileo AltBOC	1191.7950 MHz	✓
GLONASS L3	1202.0250 MHz	✓
Galileo E5b1	1207.1400 MHz	✓
BeiDou B2		
GPS L2	1227.6000 MHz	✓
GLONASS L2	1242.9375 - 1248.6250 MHz	✓
BeiDou B3I	1268.5200 MHz	✓
Galileo E6	1278.7500 MHz	✓
QZSS L6		
BeiDou B1I	1561.0980 MHz	✓
GPS L1 C/A	1575.4200 MHz	✓
GPS L1C		
Galileo E1		
BeiDou B1C		
GLONASS L1	1598.0625 - 1605.3750 MHz	✓
Terrastar	1545.8250 - 1545.9050 MHz	✓
Gain (LNA)	Typically 29 dB	
Noise Figure	Typically < 2 dB	

Environmental specifications**Temperature**

Type	Operating temperature [°C]	Storage temperature [°C]
GS18 I	-30 to +50	-40 to +85

Type	Operating temperature [°C]	Storage temperature [°C]
GS18 T	-40 to +65	-40 to +85
Leica SD cards	-40 to +85	-40 to +100
GEB331	-20 to +60	-40 to +70

Protection against water, dust and sand

Type	Protection
GS18 I/ GS18 T	IP66 & IP68 (IEC 60529), dust tight Protected against continuous immersion in water Tested for 2 hours in 1.40 m depth
GEB331	IP54 (IEC60529), dust protected Protection against splashing water from any direction. Humidity max. 95% non condensing.

Humidity

Protection
Up to 95%
The effects of condensation are to be effectively counteracted by periodically drying out the instrument.

6.2

Conformity to National Regulations

6.2.1

GS18

Conformity to national regulations

- FCC Part 15, 22 and 24 (applicable in US)
 - Hereby, Leica Geosystems AG declares that the radio equipment type GS18 is in compliance with Directive 2014/53/EU and other applicable European Directives.
The full text of the EU declaration of conformity is available at the following Internet address: <http://www.leica-geosystems.com/ce>.
 - This Class 2 equipment may be operated in: AT, BE, BG, CA, CH, CY, CZ, DE, DK, EE, ES, FI, FR, GB, GR, HU, IE, IS, IT, LT, LU, LV, MT, NL, NO, PL, PT, RU, RO, SE, SI, SK, US.
- CE** Class 2 equipment according to European Directive 2014/53/EU (RED) for which following EEA Member States apply restrictions on the placing on the market or on the putting into service or require authorisation for use:
- France
 - Italy
 - Norway (if used in the geographical area within a radius of 20 km from the centre of Ny-Ålesund)
- The conformity for countries with other national regulations not covered by the FCC part 22 and 24 or European Directive 2014/53/EU has to be approved prior to use and operation.

- Japanese Radio Law and Japanese Telecommunications Business Law Compliance.
 - This device is granted pursuant to the Japanese Radio Law (電波法) and the Japanese Telecommunications Business Law (電気通信事業法).
 - This device should not be modified (otherwise the granted designation number will become invalid).

Frequency band

Type	Frequency band [MHz]
GS18	1227.60 1246.4375 - 1254.3 1575.42 1602.5625 - 1611.5
GS18, Bluetooth	2402 - 2480
GS18, WLAN	2401 - 2495
GS18, Radio	403 - 473
GS18, Cellular phone	Dual-Band GSM 900 / 1800 & Tri-Band UMTS 900 / 1800 / 2100 & Penta-Band LTE 800 (B20) / 900 (B8) / 1800 (B3) / 2100 B(7) / 2600 (B1)
GS18, Cellular phone (NAFTA)	Quad-Band GSM 850 / 900 / 1800 / 1900 & Tri-Band UMTS 850 / AWS 1700/2100 / 1900 & Penta-Band LTE 700 (B13) / 700 (B17) / 850 (B5) / AWS 1700/2100 (B4) / 1900 (B2)
GS18, Cellular phone (Japan)	Tri-Band UMTS 800 B6 / 800 B19 / 2100 B1 & Tri-Band LTE 800 (B19) / 1800 (B3) / 2100 (B1)

Output power

Type	Output power [mW]
GNSS	Receive only
Bluetooth	5
Radio	1000
WLAN	100
GS18 GSM	1000 / 2000
GS18 UMTS	250
GS18 LTE	200

Antenna

Type	Antenna	Gain [dBi]
GNSS	Internal GNSS antenna element (receive only)	-
Bluetooth	Internal Microstrip antenna	2 max.
UHF	External antenna	0
WLAN	Internal Patch antenna	2 max.
GSM/UMTS/LTE	External antenna	2 max.

Dangerous Goods Regulations

Many products of Leica Geosystems are powered by Lithium batteries. Lithium batteries can be dangerous under certain conditions and can pose a safety hazard. In certain conditions, Lithium batteries can overheat and ignite.



When carrying or shipping your Leica product with Lithium batteries onboard a commercial aircraft, you must do so in accordance with the **IATA Dangerous Goods Regulations**.



Leica Geosystems has developed **Guidelines** on "How to carry Leica products" and "How to ship Leica products" with Lithium batteries. Before any transportation of a Leica product, we ask you to consult these guidelines on our web page (<http://www.leica-geosystems.com/dgr>) to ensure that you are in accordance with the IATA Dangerous Goods Regulations and that the Leica products can be transported correctly.



Damaged or defective batteries are prohibited from being carried or transported onboard any aircraft. Therefore, ensure that the condition of any battery is safe for transportation.

Software Licence Agreement

This product contains software that is preinstalled on the product, or that is supplied to you on a data carrier medium, or that can be downloaded by you online according to prior authorisation from Leica Geosystems. Such software is protected by copyright and other laws and its use is defined and regulated by the Leica Geosystems Software Licence Agreement, which covers aspects such as, but not limited to, Scope of the Licence, Warranty, Intellectual Property Rights, Limitation of Liability, Exclusion of other Assurances, Governing Law and Place of Jurisdiction. Please make sure, that at any time you fully comply with the terms and conditions of the Leica Geosystems Software Licence Agreement.

Such agreement is provided together with all products and can also be referred to and downloaded at the Leica Geosystems home page at <http://leica-geosystems.com/about-us/compliance-standards/legal-documents> or collected from your Leica Geosystems distributor.

You must not install or use the software unless you have read and accepted the terms and conditions of the Leica Geosystems Software Licence Agreement. Installation or use of the software or any part thereof, is deemed to be an acceptance of all the terms and conditions of such Licence Agreement. If you do not agree to all or some of the terms of such Licence Agreement, you must not download, install or use the software and you must return the unused software together with its accompanying documentation and the purchase receipt to the distributor from whom you purchased the product within ten (10) days of purchase to obtain a full refund of the purchase price.

Appendix A

Pin Assignments and Sockets

Description

Some applications require knowledge of the pin assignments for the instrument ports.

In this chapter, the pin assignments and sockets for the instrument ports are explained.

Pin assignments for port P1

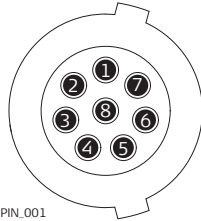

PIN_001

Pin	Signal Name	Function	Direction
1	USB_D+	USB data line	In or out
2	USB_D-	USB data line	In or out
3	GND	Signal ground	-
4	RxD	RS232, receive data	In
5	TxD	RS232, transmit data	Out
6	ID	Identification pin	In or out
7	PWR	Power input, 10.5 V-28 V	In
8	GPIO	RS232, general-purpose signal	In or out

851580-2.0.0en

Original text (851580-2.0.0en)

Published in Switzerland

© 2020 Leica Geosystems AG, Heerbrugg, Switzerland



- when it has to be **right**



Leica Geosystems AG

Heinrich-Wild-Strasse

CH-9435 Heerbrugg

Switzerland

Phone +41 71 727 31 31

www.leica-geosystems.com

